

ROCKWELL LAVATORY PAN WITH LOW LEVEL CISTERN

The Rockwell lavatory pan is shown here with a low level cistern, seat and flush handle in white/ Snowdrop. Other Rockwell colored ceramics available: green/Willow, blue/Powder and yellow/Sherbet. It can also be used with a close coupled or concealed cistern.

Produced in a traditional manner in England.



Side view

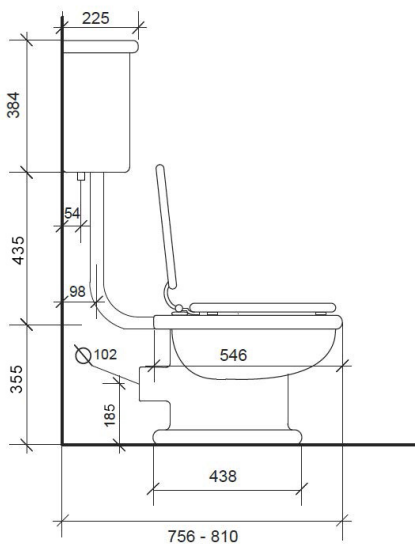

Front view

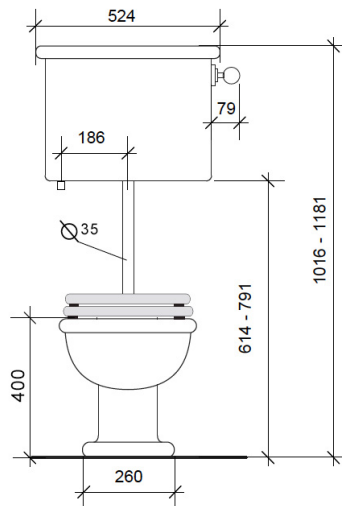

Cistern inlet pipe position diagram

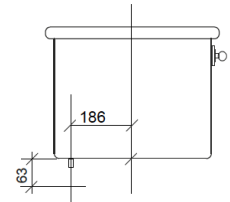

supplied with a bent service valve

Side view with optional horizontal pan connector

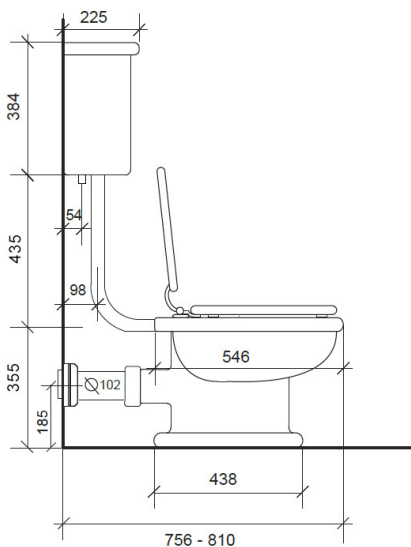

Side view with optional vertical pan connector

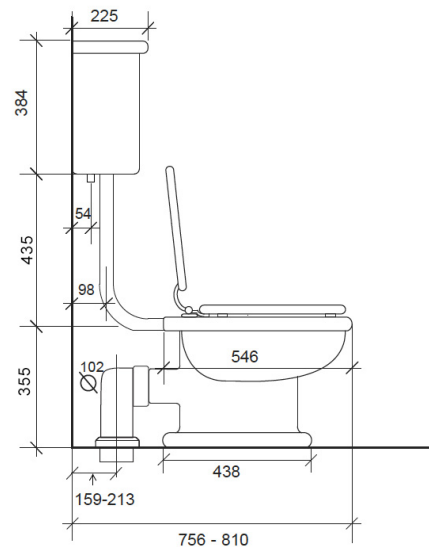

ROCKWELL LAVATORY PAN WITH LOW LEVEL CISTERN

(Page 2/2)

Horizontal pan connector

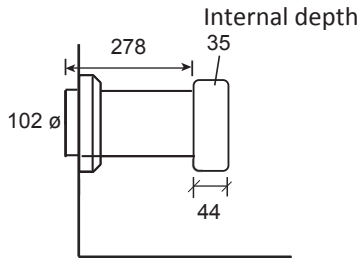

Vertical pan connector

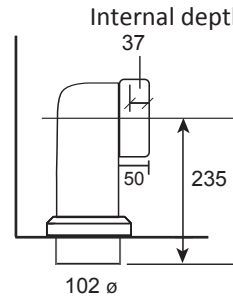

Collar for horizontal and vertical pan connector

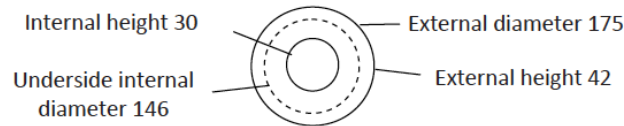

Technical Details

Flush motion: Syphonic with flush handle

Depth: 756 - 810mm

Height: 1016 - 1181mm

Inlet connection size: 1/2"

Cistern width: 524mm

Rim height: 400mm

Water Pressure Maximum: 6 bar

Water Pressure Minimum: 1 bar

Outlet size: 102mm

Water consumption: 6 litres

Optional china pan connector, straight or 90° available

Codes & Standards

Ceramic complies to CE Standards

Flush mechanism complies to WRAS Standards



Product Notes

All dimensions (in mm) are based on original specifications and are subject to change and variation.